

Radio/Cassette

# Flensburg CC 28

Operating instructions

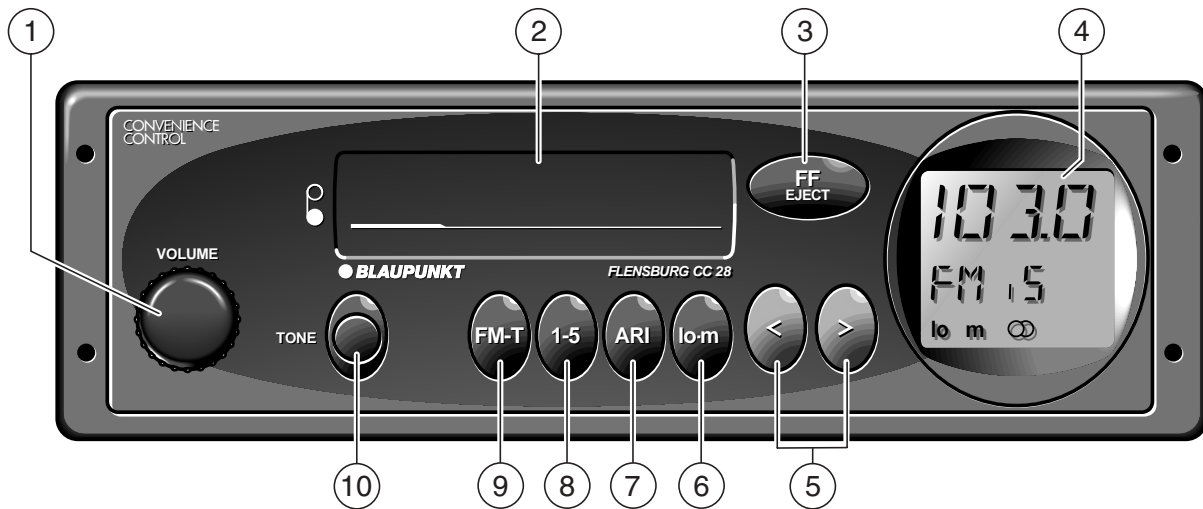



# Table of Contents

<b>Important information .....</b>	<b>11</b>	<b>Cassette tape operation .....</b>	<b>13</b>
Traffic safety .....	11	Insert cassette tape .....	13
Installation / Hook-up .....	11	Remove cassette tape .....	13
<b>Radio operation .....</b>	<b>11</b>	Fast forward .....	13
Station search .....	11	Care of your audio equipment .....	13
Manual station search .....	11	<b>Appendix .....</b>	<b>14</b>
Adjusting station search sensitivity for FM .....	11	Technical data .....	14
Stereo - mono switch .....	11		
Storing stations .....	12		
Storing the strongest stations automatically .....	12		
Recalling stored stations .....	12		
<b>Traffic messages (ARI) .....</b>	<b>12</b>		
Switching the traffic messages (ARI) on and off .....	12		
Warning beep .....	12		
Switching the warning beep off .....	13		
Automatic search start .....	13		

# Legend

## ① On/off

Turn knob.

On ↻

Off ↻

Adjust volume:

Turn knob.

## ② Cassette tape slot

## ③ FF - Fast forward

Start/end fast forward: press button gently.

### Eject - Eject cassette tape:

Press button firmly.

## ④ Display for

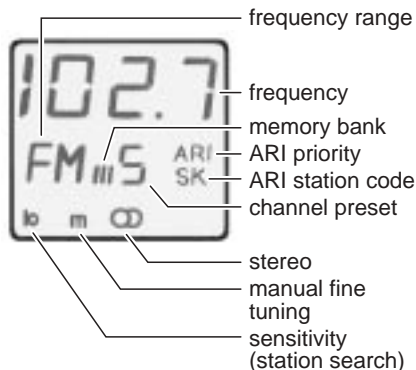

## ⑤ < >

### Station selection

automatic or manual ("m" in display).

Switch over by pressing **lo • m** ⑥

## ⑥ lo • m

Changing the search tuning sensitivity for FM stations

**lo** lit up in the display indicates normal sensitivity for the station search function.

**lo** not lit up in the display indicates high sensitivity for the station search function.

**m** lit up indicates manual station fine tuning.

Added feature:

Switch over from stereo to mono:

Press **lo • m** for longer than 2 seconds.

## ⑦ ARI (traffic messages)

When ARI is visible in the display, you are able to tune into only those radio stations which broadcast traffic messages.

## ⑧ 1-5

For storing and recalling radio stations

## ⑨ FM•T (frequency modulation)

Switch for the FM memory banks I, II, III and "T" (Travelstore) - for storing and recalling the six nearest, strongest station signals.

### Store "T":

Press **FM•T** until the search begins in the display.

### Recall "T":

Press **FM•T** until T appears in the display. Then press the station button quickly and repeatedly if necessary.

## ⑩ TONE

Adjust tone.

↻ more bass

↻ more treble

## Important information

### Traffic safety

As the driver of a motor vehicle, it is your responsibility to pay attention to the traffic situation at all times. Never use your car radio in a way that could distract you. Should the traffic situation become particularly demanding, we would advise you not to use the radio. Please keep in mind that you travel a distance of 14 m per second at a speed of only 50 km/h. When adjusting the volume, make sure that you are still able to hear sounds coming from outside of the vehicle, so that you are always able to react to warning signals.

### Installation / Hook-up

If you would like to install your new car radio yourself or add other audio components to the existing ones, then please read the enclosed instructions on installation and hook-up carefully.

Do not ground the loudspeaker outputs! Use only Blaupunkt-certified accessories and spare parts.

## Radio operation

With this car radio you can receive FM frequencies ranging from 87.5 to 108 MHz.

### Station search

**m** should not be lit up in the display. If it is, switch it off by pressing **lo • m**

- **< >** press right or left.  
The car radio will automatically tune into the next station.

If you hold the button pressed, the search function will forward quickly.

### Manual station search

**m** (manual) must be lit up in the display. If it is not, switch it on by pressing **lo • m**.

- **< >** press right or left quickly.  
The frequency will move up or down in short intervals.

If you hold the button pressed, then the frequencies will move up or down more quickly.

### Adjusting station search sensitivity for FM

You can adjust the sensitivity of the automatic station search.

- Press **lo • m**.  
When "lo" is visible in the display, then only those stations with relatively strong signals will be picked up (low sensitivity).  
When "lo" is not visible in the display, then stations with weaker signals will also be picked up (high sensitivity).

### Stereo - mono switch

If you would like to switch between stereo and mono reception:

- Press **lo • m** for approximately 2 seconds.  
During mono reception the stereo symbol  will disappear from the display.

Each time the car radio is switched on, the reception will automatically be set to stereo. The radio will automatically switch to mono when the reception conditions are poor.

## Storing stations

For each memory bank (I, II, III, T) you can store up to five stations using the button **1-5**.

- Select the memory bank by pressing **FM•T**.
- Select the button **1-5** to store the new station and press it.
- Press **< >** to tune in the station you want to store (automatically or manually).
- Press the button **1-5** and hold it. First the station will be muted and then become audible again.

The station has been stored in the memory bank.

The corresponding memory bank and the button preset will appear in the display.

### Note:

If you tune into a station which has already been stored, then the corresponding button preset and the memory bank will flash in the display for approximately 5 seconds.

## Storing the strongest stations automatically

### (Travelstore)

In your reception area you can automatically store the five nearest FM stations, sorted according to their frequencies.

This feature is particularly useful when you are travelling.

- Press **FM•T** for at least 2 seconds. The radio will search for the nearest FM stations and store them in the memory bank "T" (Travelstore). When the process has been completed, the first station will be set.

If you wish, you can also store stations in the Travelstore memory bank manually.

## Recalling stored stations

You can recall the stored stations by pressing the corresponding buttons.

- Select the memory bank. Press **FM•T** until I, II, III or T appears in the display.
- Select the station by pressing the button **1-5**, press repeatedly if necessary.

## Traffic messages (ARI)

Many FM stations broadcast traffic news for their reception area at regular intervals. Stations using the ARI system broadcast an "ARI signal" during their programmes, so that your car radio can recognize them. Another signal is broadcast to indicate the beginning and end of a traffic message. These traffic messages are broadcast at a preset volume. If you are playing a cassette, it will be interrupted until the traffic message has ended and will then resume operation.

### Switching the traffic messages (ARI) on and off

If you want to switch the reception of traffic messages (ARI) on or off

- Press **ARI**.  
ARI will light up in the display, when the reception is switched on.

Now the radio will only pick up those stations broadcasting the ARI signal.

### Warning beep

Should you leave the reception area of the station you are tuned to, then you will hear a warning beep after approximately 30 seconds. If you should press a button preset for a station which does not broadcast the ARI signal, then you will also hear a warning beep.

## Cassette tape operation

### Switching the warning beep off

- a) Tune to a different station broadcasting the ARI signal:
- Press < > or
  - select a stored station with the ARI signal by pressing the button preset **1-5**.
- or
- b) Switch the traffic message priority off:
- Press **ARI**.

### Automatic search start

(during cassette operation)

If you should leave the reception area of your ARI station while you are playing a cassette, then the car radio will automatically tune into a different station broadcasting the ARI signal.

### Insert cassette tape

- Switch the car radio on.
- Insert a cassette tape with the empty reel facing forward and the open side facing to the left.

Tape playback will begin.

When the tape has run to the end, the car radio will switch on automatically.

### Remove cassette tape

- Press **FF / Eject** firmly.  
The cassette will be ejected.

### Fast forward

To begin and end fast forwarding,

- Press **FF / Eject** gently.

### Care of your audio equipment

We recommend that you use only C60/C90 cassette tapes in your car radio. Protect your cassettes from dirt, dust and temperatures exceeding 50 °C. During cold weather, allow cold cassettes to warm up somewhat before playing them in order to avoid uneven tape transport. Operating problems and sound distortions may occur after approximately 100 hours of playing time and are caused by dust particles which adhere to the rubber roller pad and the tape head. Use a cleaner cassette to remove normal dirt build-up. If more dirt than usual has accumulated, use a cotton bud dipped in rubbing alcohol to clean these parts. Never use any hard tools.

# Appendix

## Technical data

### Amplifier:

Output power: 2 x 5.5 W RMS power  
according to DIN 45324/  
3.1 at 4  $\Omega$

### FM:

Sensitivity: 1.3  $\mu$ V at 26 dB  
S/N ratio

Response: 35 - 15 000 Hz (-3 dB)

### Cassette:

Response: 40 - 14 000 Hz (-3 dB)

Information subject to change!



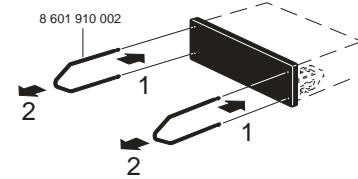
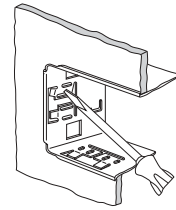
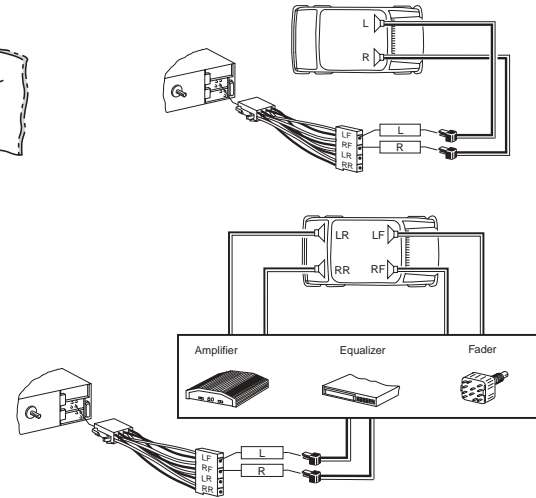
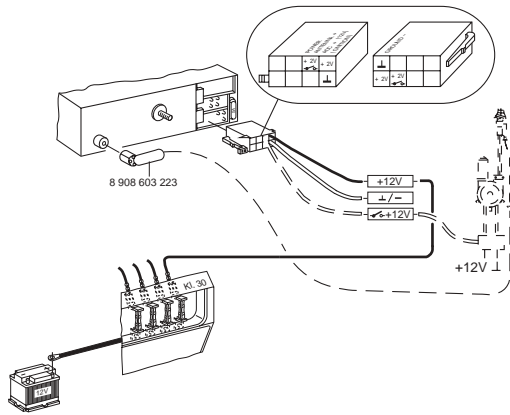
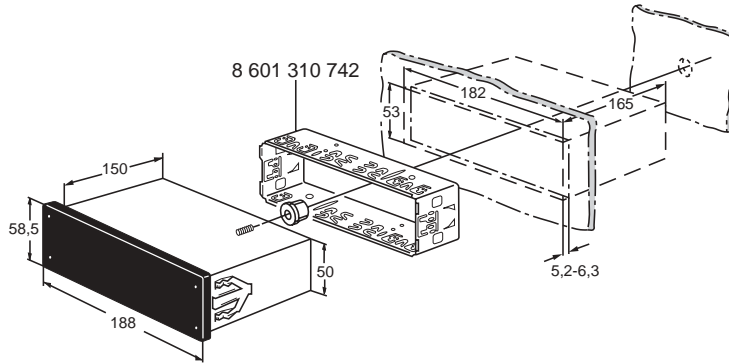

**Blaupunkt-Werke GmbH**  
**Bosch Gruppe**

K7/VKD 8 622 401 405

